

# ANALYTICAL BALANCES AS/X



Balances series AS/X represent standard level of analytical balances. They are equipped with backlit graphic display. Accuracy and precise measurement of the balances are determined by automatic internal calibration, dependant on time and temperature changes.









Analytical balances AS/X series are offered with following capacities: 110, 160, 220, 310 g with readability of 0,1 mg, 60 g with readability of 0,01 mg and 60/220 g with readability of 0,01/0,1 mg.

AS/X balances are equipped with optional pipette calibration as well as automatic door opening system.

GLP procedure of these balances is a report from calibration process of the balance, and this information has unchangeable shape (no modification possible).

User has access to big measuring chamber with sliding doors and sliding top glass. Each balance is equipped with RS 232 output and possibility of connection of additional display as standard.

Balances are equipped with possibility of weighing loads outside the main weighing platform (so called under hook weighing). This means of mass measuring is an alternative for loads with non-standard dimensions and shapes and those which create magnetic field. Under hook weighing is also applied for density determination procedures.

-  Counting pieces
-  Filling
-  Animal weighing
-  Density determination
-  Checkweighing
-  Percentage
-  Statistics
-  Formulation

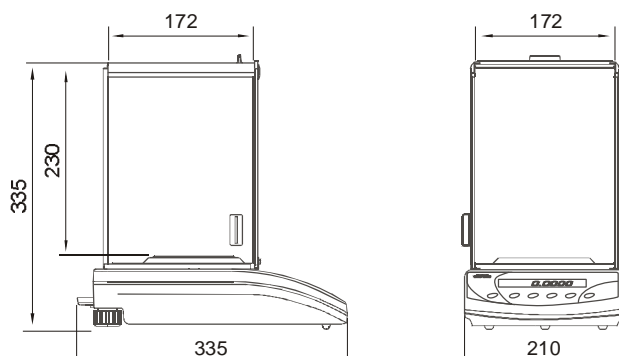

## Technical data:

	AS 110/X	AS 160/X	AS 220/X	AS 310/X
Max capacity	110 g	160 g	220 g	310 g
Minimal load	10 mg	10 mg	10 mg	10 mg
Readability	0,1 mg	0,1 mg	0,1 mg	0,1 mg
Tare range	-110 g	-160 g	-220 g	-310 g
Working temperature	+10° - +45°C			
Repeatability	0,1 mg	0,15 mg	0,15 mg	0,2 mg
Linearity	± 0,3 mg	± 0,3 mg	± 0,3 mg	± 0,3 mg
Sensitivity drift	2 ppm/°C in temperature +15° - +35°C			
Power supply	230V / 11V AC or 120V / 11V AC			
Calibration	internal (automatic)			
Pan size	ø 85 mm	ø 85 mm	ø 85 mm	ø 85 mm

## Additional equipment:

ANTI-VIBRATION TABLE (MILD STEEL OR STAINLESS STEEL)	RACK FOR UNDER-HOOK WEIGHING
PRINTERS: KAFKA 1, KAFKA 1Z, KAFKA SQ	ADDITIONAL LCD DISPLAY
PRINTER EPSON: TM-U220D, TM-U220B, TM-U220A	EXTERNAL RECHARGEABLE BATTERY WITH CHARGER
DENSITY KIT FOR SOLIDS AND LIQUIDS	COMPUTER SOFTWARE: PW-WIN 2005, RAD-KEY 2000, REC-FS 2000

RADWAG

26-600 Radom Bracka Street 28 POLAND Phone: +48 48 3848800 Fax: +48 48 3850010 www.radwag.com e-mail: export@radwag.com